



CONSULTING ENGINEERING  
GEOSPATIAL SERVICES

ILLINOIS | SWANSEA  
WATERLOO  
EDWARDSVILLE  
PEORIA

MISSOURI | ST. CHARLES  
ST. LOUIS

TENNESSEE | NASHVILLE

**THOUVENOT, WADE  
& MOERCHEN, INC.**

ST. LOUIS OFFICE  
720 OLIVE STREET, SUITE 200A  
ST. LOUIS, MISSOURI  
63101  
(314) 241-6300  
WWW.TWM-INC.COM

211243

PROJECT:  
LONGVIEW BOULEVARD  
IMPROVEMENTS  
TALYOR AVE. TO  
WOODLAWN AVE.

TITLE:  
PRELIMINARY PLAN

SHEET NO.  
C-1

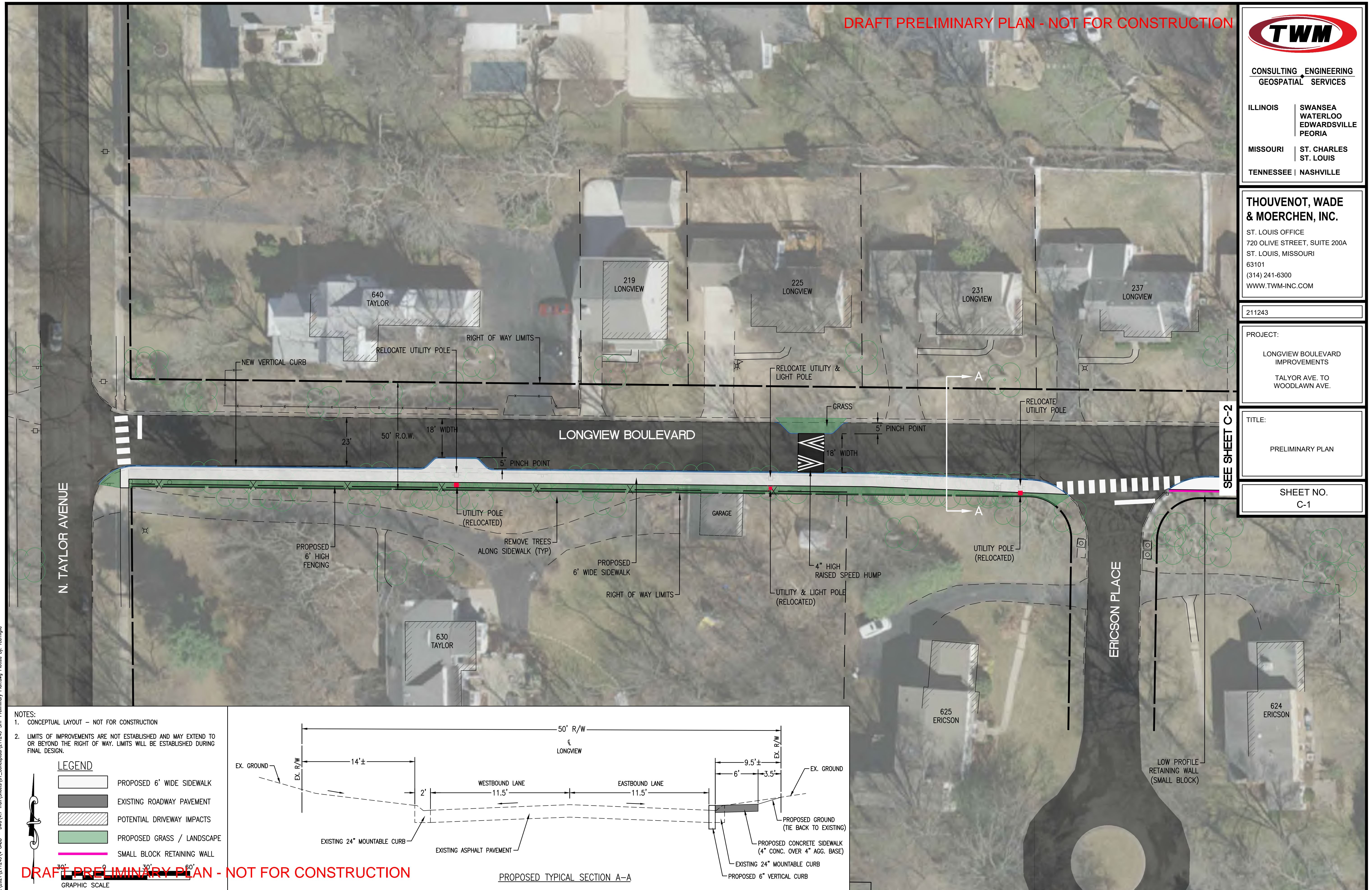

SEE SHEET C-2

- NOTES:
- CONCEPTUAL LAYOUT - NOT FOR CONSTRUCTION
  - LIMITS OF IMPROVEMENTS ARE NOT ESTABLISHED AND MAY EXTEND TO OR BEYOND THE RIGHT OF WAY. LIMITS WILL BE ESTABLISHED DURING FINAL DESIGN.

**LEGEND**

- PROPOSED 6' WIDE SIDEWALK
- EXISTING ROADWAY PAVEMENT
- POTENTIAL DRIVEWAY IMPACTS
- PROPOSED GRASS / LANDSCAPE
- SMALL BLOCK RETAINING WALL

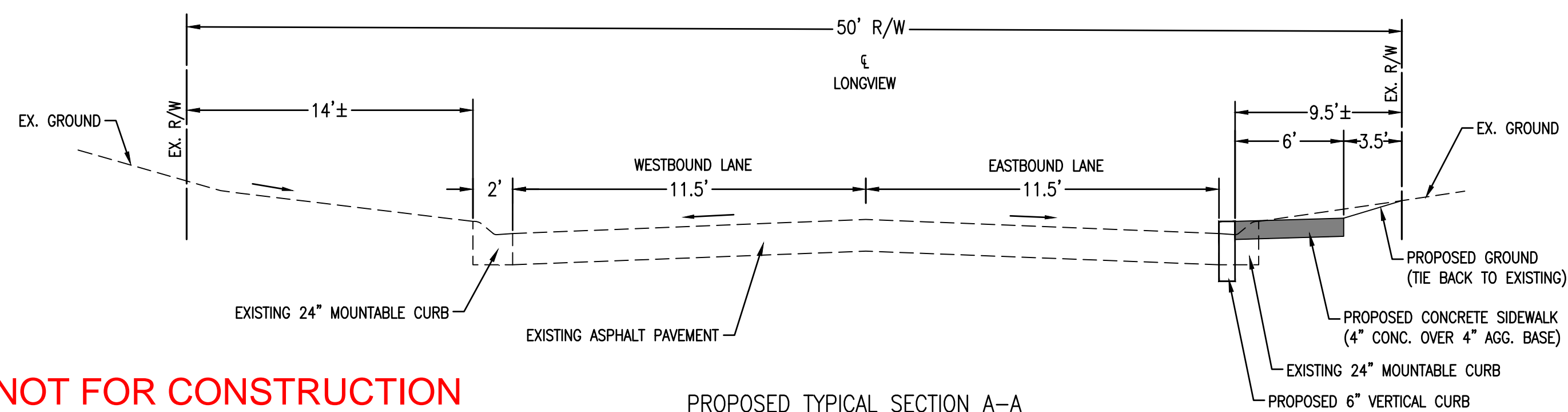

PROPOSED TYPICAL SECTION A-A

P:\2021\211243\4 CAD - DWG\4.7 Tran\Sheets\01\_Conceptual\211243-SHF-Preliminary Plan.dwg Plotted By: rcmjgla

NOTES:  
 1. CONCEPTUAL LAYOUT - NOT FOR CONSTRUCTION  
 2. LIMITS OF IMPROVEMENTS ARE NOT ESTABLISHED AND MAY EXTEND TO OR BEYOND THE RIGHT OF WAY. LIMITS WILL BE ESTABLISHED DURING FINAL DESIGN.

LEGEND

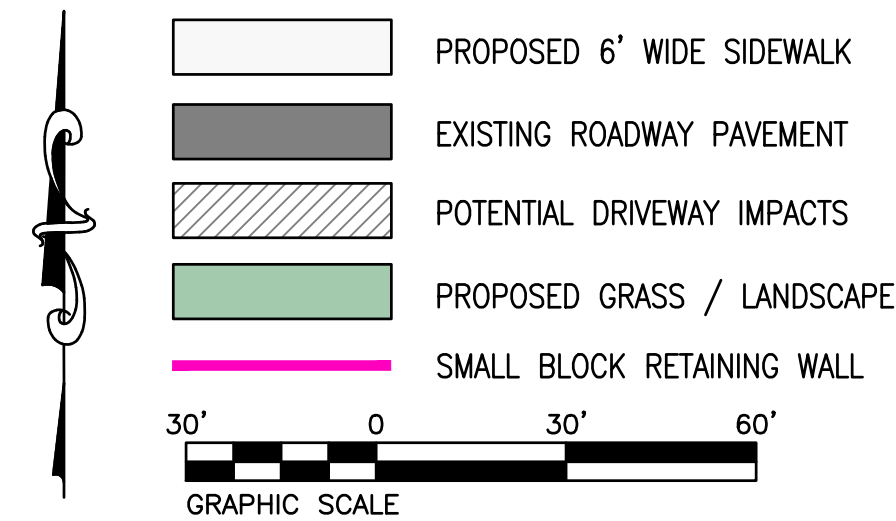

DRAFT PRELIMINARY PLAN - NOT FOR CONSTRUCTION

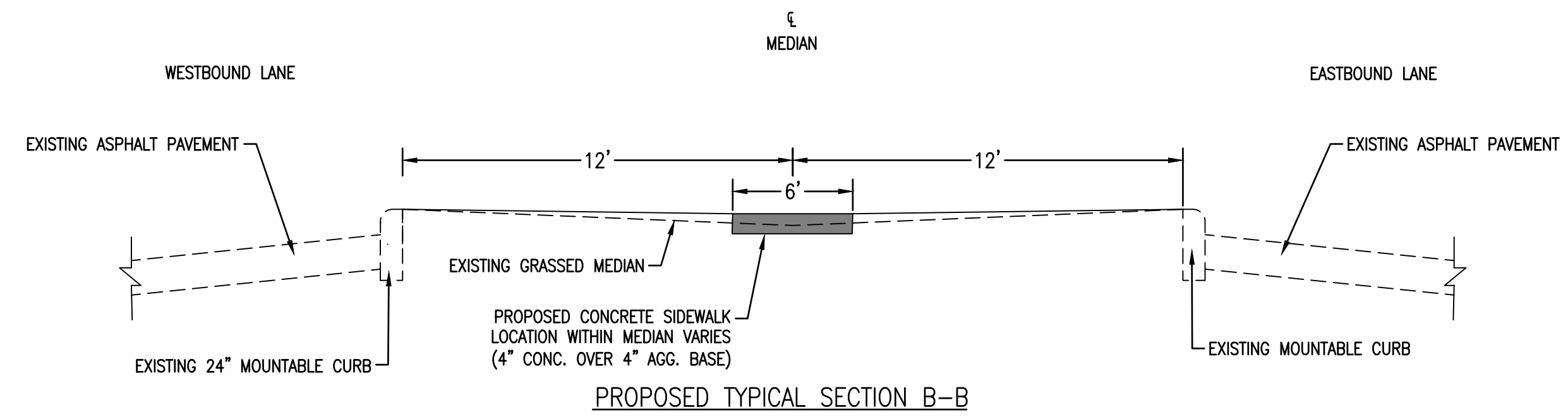

CONSULTING ENGINEERING  
 GEOSPATIAL SERVICES

ILLINOIS | SWANSEA  
 WATERLOO  
 EDWARDSVILLE  
 PEORIA

MISSOURI | ST. CHARLES  
 ST. LOUIS

TENNESSEE | NASHVILLE

THOUVENOT, WADE  
 & MOERCHEN, INC.

ST. LOUIS OFFICE  
 720 OLIVE STREET, SUITE 200A  
 ST. LOUIS, MISSOURI  
 63101  
 (314) 241-6300  
 WWW.TWM-INC.COM

211243

PROJECT:  
 LONGVIEW BOULEVARD  
 IMPROVEMENTS  
 TALYOR AVE. TO  
 WOODLAWN AVE.

TITLE:  
 PRELIMINARY PLAN

SHEET NO.  
 C-2



SEE SHEET C-1

SEE SHEET C-3

DRAFT PRELIMINARY PLAN - NOT FOR CONSTRUCTION

NOTES:  
 1. CONCEPTUAL LAYOUT - NOT FOR CONSTRUCTION  
 2. LIMITS OF IMPROVEMENTS ARE NOT ESTABLISHED AND MAY EXTEND TO OR BEYOND THE RIGHT OF WAY. LIMITS WILL BE ESTABLISHED DURING FINAL DESIGN.

**LEGEND**

-  PROPOSED 6' WIDE SIDEWALK
-  EXISTING ROADWAY PAVEMENT
-  POTENTIAL DRIVEWAY IMPACTS
-  PROPOSED GRASS / LANDSCAPE

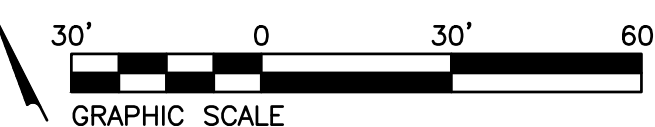

DRAFT PRELIMINARY PLAN - NOT FOR CONSTRUCTION



**CONSULTING ENGINEERING  
 GEOSPATIAL SERVICES**

ILLINOIS | SWANSEA  
 WATERLOO  
 EDWARDSVILLE  
 PEORIA

MISSOURI | ST. CHARLES  
 ST. LOUIS

TENNESSEE | NASHVILLE

**THOUVENOT, WADE  
 & MOERCHEN, INC.**

ST. LOUIS OFFICE  
 720 OLIVE STREET, SUITE 200A  
 ST. LOUIS, MISSOURI  
 63101  
 (314) 241-6300  
 WWW.TWM-INC.COM

211243

PROJECT:  
 LONGVIEW BOULEVARD  
 IMPROVEMENTS  
 TALYOR AVE. TO  
 WOODLAWN AVE.

TITLE:  
 PRELIMINARY PLAN

SHEET NO.  
 C-3



SEE SHEET C-2

SEE SHEET C-4

DRAFT PRELIMINARY PLAN - NOT FOR CONSTRUCTION

P:\2021\211243\4 CAD - DWG\4.7 Tran\Sheets\01\_Conceptual\211243-SHF-Preliminary Plan.dwg Plotted By: rcoemglio

DRAFT PRELIMINARY PLAN - NOT FOR CONSTRUCTION

NOTES:  
1. CONCEPTUAL LAYOUT - NOT FOR CONSTRUCTION  
2. LIMITS OF IMPROVEMENTS ARE NOT ESTABLISHED AND MAY EXTEND TO OR BEYOND THE RIGHT OF WAY. LIMITS WILL BE ESTABLISHED DURING FINAL DESIGN.



CONSULTING ENGINEERING  
GEOSPATIAL SERVICES

ILLINOIS | SWANSEA  
WATERLOO  
EDWARDSVILLE  
PEORIA

MISSOURI | ST. CHARLES  
ST. LOUIS

TENNESSEE | NASHVILLE

**THOUVENOT, WADE  
& MOERCHEN, INC.**

ST. LOUIS OFFICE  
720 OLIVE STREET, SUITE 200A  
ST. LOUIS, MISSOURI  
63101  
(314) 241-6300  
WWW.TWM-INC.COM





211243

PROJECT:  
LONGVIEW BOULEVARD  
IMPROVEMENTS  
TALYOR AVE. TO  
WOODLAWN AVE.

TITLE:  
PRELIMINARY PLAN

SHEET NO.  
C-4

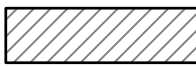
**LEGEND**

-  PROPOSED 6' WIDE SIDEWALK
-  EXISTING ROADWAY PAVEMENT
-  POTENTIAL DRIVEWAY IMPACTS
-  PROPOSED GRASS / LANDSCAPE

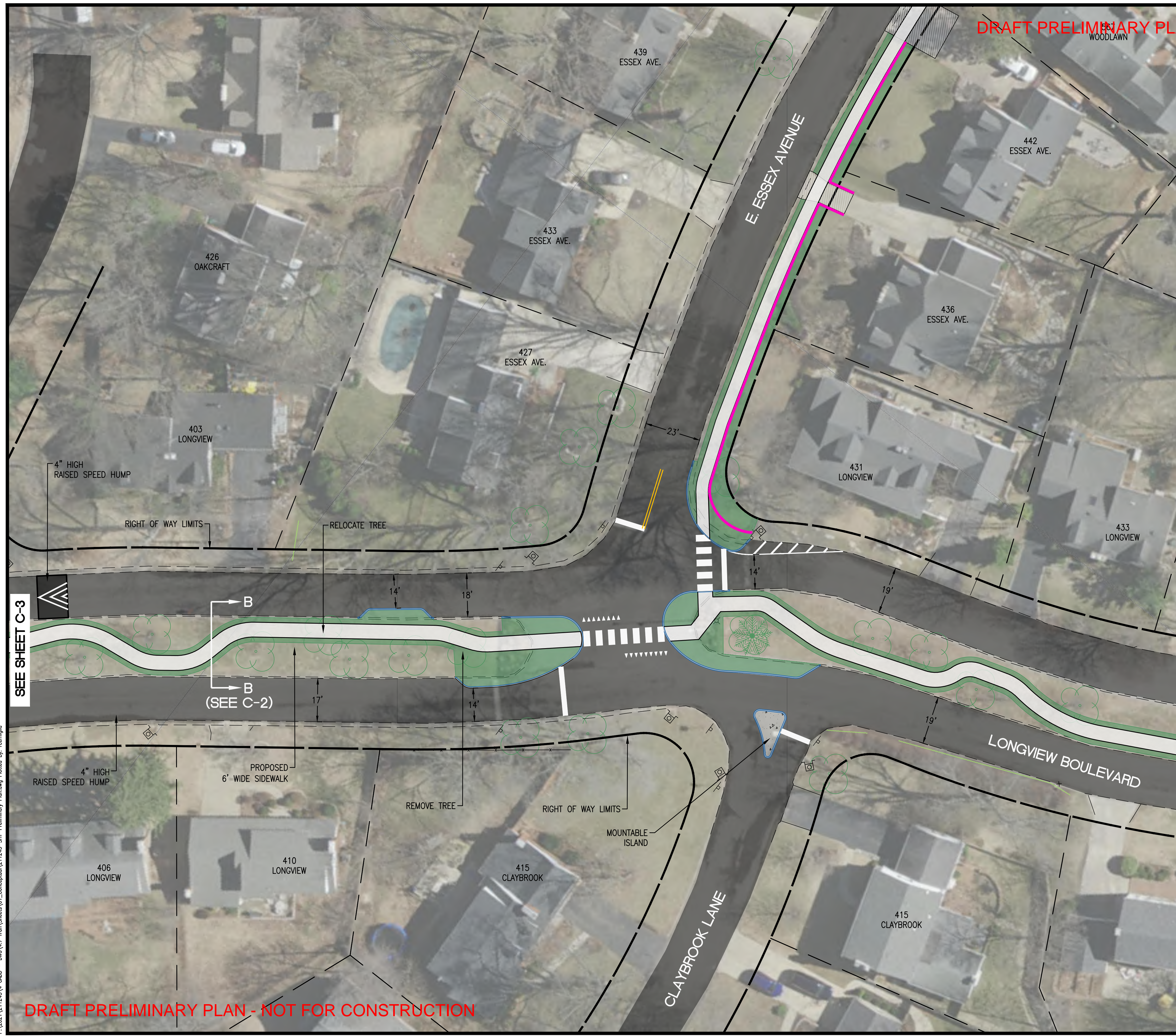
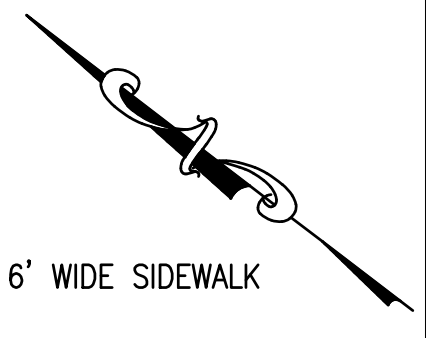
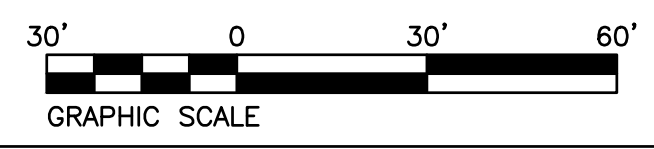

SEE SHEET C-3

SEE SHEET C-5

DRAFT PRELIMINARY PLAN - NOT FOR CONSTRUCTION

P:\2021\211243\4 CAD - DWG\4.7 Tran\Sheets\01\_Conceptual\211243-SHF-Preliminary Plan.dwg Plotted By: rcoemglio

DRAFT PRELIMINARY PLAN - NOT FOR CONSTRUCTION

NOTES:  
 1. CONCEPTUAL LAYOUT - NOT FOR CONSTRUCTION  
 2. LIMITS OF IMPROVEMENTS ARE NOT ESTABLISHED AND MAY EXTEND TO OR BEYOND THE RIGHT OF WAY. LIMITS WILL BE ESTABLISHED DURING FINAL DESIGN.

**LEGEND**

- PROPOSED 6' WIDE SIDEWALK
- EXISTING ROADWAY PAVEMENT
- POTENTIAL DRIVEWAY IMPACTS
- PROPOSED GRASS / LANDSCAPE

30' 0 30' 60'  
 GRAPHIC SCALE

**CONSULTING ENGINEERING  
 GEOSPATIAL SERVICES**

ILLINOIS | SWANSEA  
 WATERLOO  
 EDWARDSVILLE  
 PEORIA

MISSOURI | ST. CHARLES  
 ST. LOUIS

TENNESSEE | NASHVILLE

**THOUVENOT, WADE  
 & MOERCHEN, INC.**

ST. LOUIS OFFICE  
 720 OLIVE STREET, SUITE 200A  
 ST. LOUIS, MISSOURI  
 63101  
 (314) 241-6300  
 WWW.TWM-INC.COM

211243

PROJECT:  
 LONGVIEW BOULEVARD  
 IMPROVEMENTS  
 TALLYOR AVE. TO  
 WOODLAWN AVE.

TITLE:  
 PRELIMINARY PLAN

SHEET NO.  
 C-5

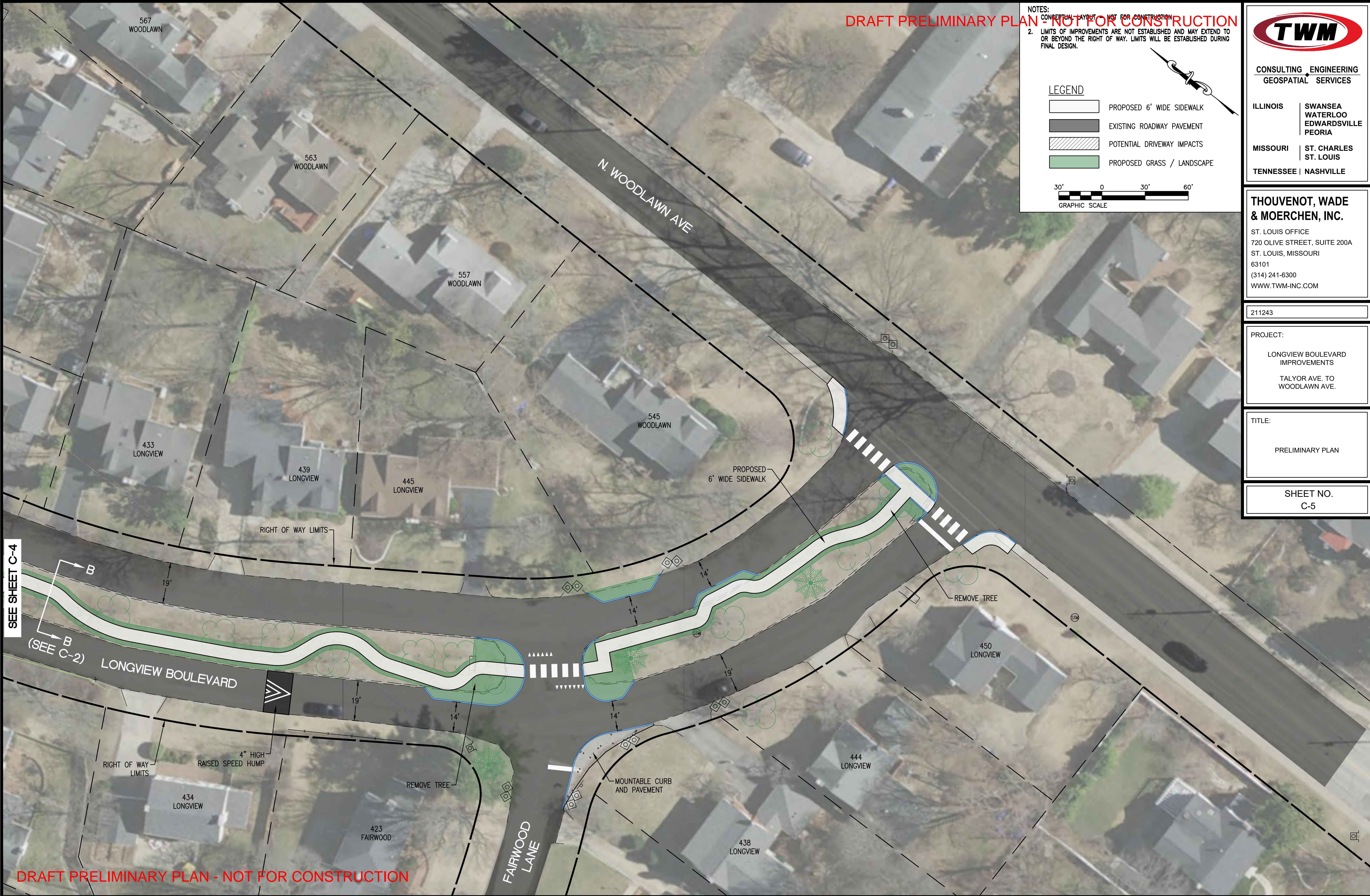

SEE SHEET C-4

(SEE C-2)

DRAFT PRELIMINARY PLAN - NOT FOR CONSTRUCTION

P:\2021\211243\4 CAD - DWG\4.7 Tran\Sheets\01\_Conceptual\211243-SHP-Preliminary Plan.dwg Plotted By: rcoemglio

DRAFT PRELIMINARY PLAN - NOT FOR CONSTRUCTION



CONSULTING ENGINEERING  
GEOSPATIAL SERVICES

ILLINOIS | SWANSEA  
WATERLOO  
EDWARDSVILLE  
PEORIA

MISSOURI | ST. CHARLES  
ST. LOUIS

TENNESSEE | NASHVILLE

**THOUVENOT, WADE  
& MOERCHEN, INC.**

ST. LOUIS OFFICE  
720 OLIVE STREET, SUITE 200A  
ST. LOUIS, MISSOURI  
63101  
(314) 241-6300  
WWW.TWM-INC.COM

211243

PROJECT:  
LONGVIEW BOULEVARD  
IMPROVEMENTS  
TALYOR AVE. TO  
WOODLAWN AVE.

TITLE:  
PRELIMINARY PLAN

SHEET NO.  
C-6

SEE SHEET C-4

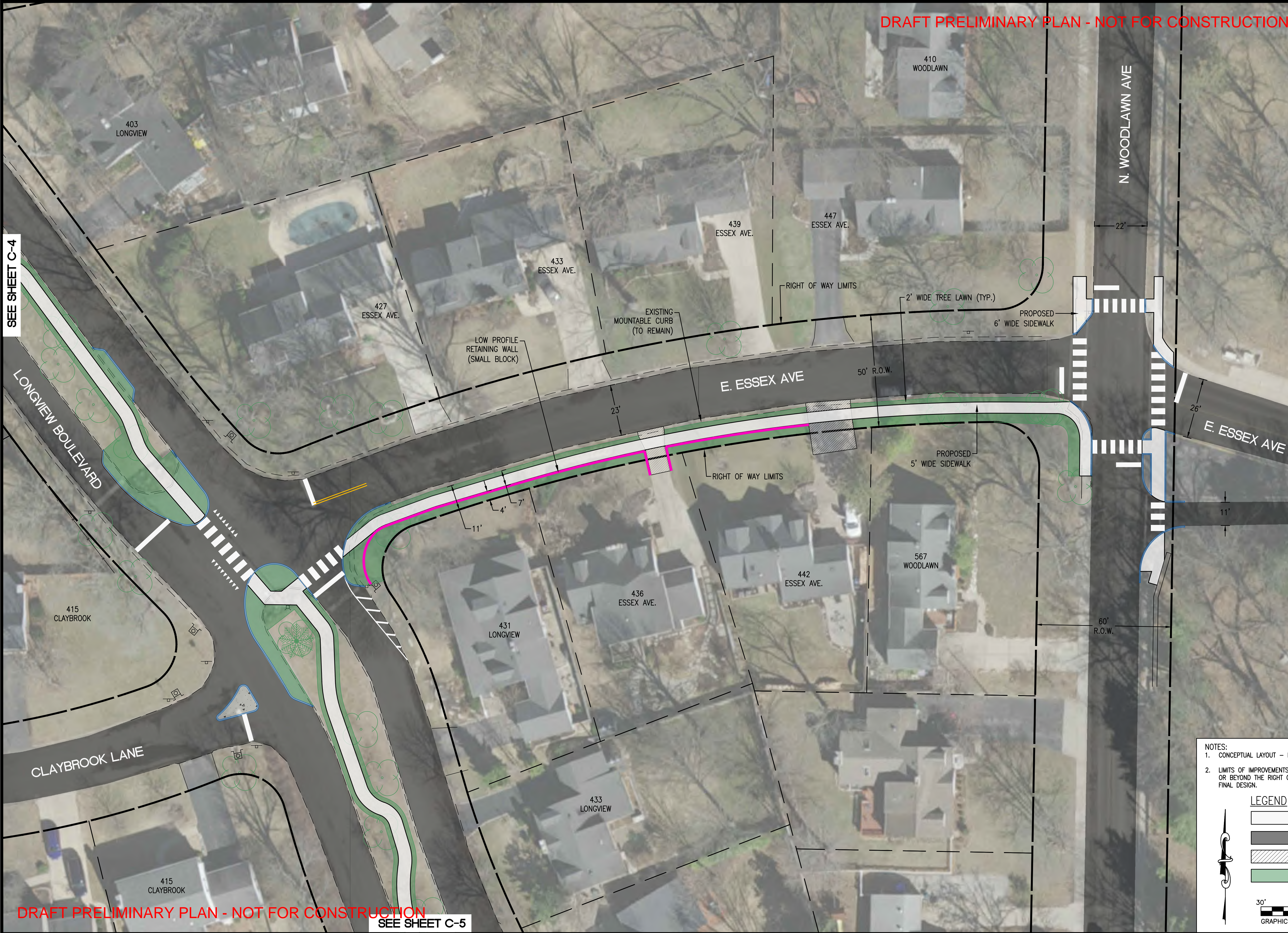

DRAFT PRELIMINARY PLAN - NOT FOR CONSTRUCTION

SEE SHEET C-5

- NOTES:
1. CONCEPTUAL LAYOUT - NOT FOR CONSTRUCTION
  2. LIMITS OF IMPROVEMENTS ARE NOT ESTABLISHED AND MAY EXTEND TO OR BEYOND THE RIGHT OF WAY. LIMITS WILL BE ESTABLISHED DURING FINAL DESIGN.

LEGEND

	PROPOSED 6' WIDE SIDEWALK
	EXISTING ROADWAY PAVEMENT
	POTENTIAL DRIVEWAY IMPACTS
	PROPOSED GRASS / LANDSCAPE

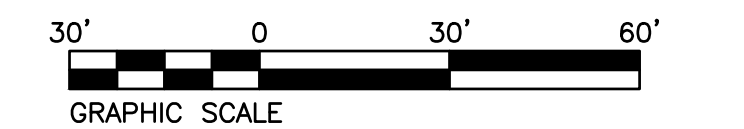

P:\2021\211243\4 CAD - DWG\4.7 Tran\Sheets\01\_Conceptual\211243-SHP-Preliminary Plan.dwg Plotted By: rcoenigla